

506

BEARING

Polyester Fabric, Rod and Piston and Coil

DESIGN

The Hallite 506 bearing strip is designed to provide an extremely effective, hard wearing, and easy-to-use bearing solution for reciprocating, oscillating, and slow rotary movement applications. Manufactured to very tight tolerances, the Hallite 506 is capable of withstanding extreme side loads and preventing metal-to-metal contact between the piston and the bore or the rod and the gland. The Hallite 506 has become the industry standard favoured by designers and specifiers alike in many of today's most arduous hydraulic applications around the world.

The Hallite 506 is available in three forms: cut bearing rings, spiral lengths, and flat coils. Spiral lengths and flat coils are recommended to customers who want to cut their own custom sizes. Spiral lengths are recommended to distributors or customers who may need to fit a wide range of application sizes in a particular cross section.

The Hallite 506 bearing strip is manufactured by a patented process, using a woven fabric reinforced polyester resin material, and is proven to be compatible with a wide range of fluids including: mineral oils, water-based fluids, and phosphate esters. The construction of the bearing strip incorporates micro-indentations on the surface to trap fluid and provide built-in lubrication to the bearing.

The rectangular section strip is available in a wide range of inch and metric sizes, including cross sections specified in ISO 10766.

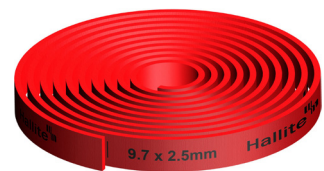

FEATURES

- Tight tolerances
- Available in ready-made bearings cut to size and to customer specifications
- Available in spiral lengths and flat coils
- Low friction

MATERIALS

This product comes in a number of material options to extend operating conditions. Contact your local Hallite technical team to decide which is best for your application. Use the part designator in the table below as the last digit of the part number to specify material choice when ordering. For further material details, please refer to the Hallite Material Table in front of catalogue.

MATERIAL OPTIONS	Name	Type	Colour
Standard	TSE 041	Thermoset Polyester	Red
Optional	TSE 042	Thermoset Polyester (Reduced Friction)	Red

TECHNICAL DETAILS

OPERATING CONDITIONS	METRIC		INCH	
Temperature Range	-40°C +120°C		-40°F +250°F	
Limiting PV Values Lubricated*	Speed(V) m/sec	Pressure(P) MN/m ²	Speed(V) ft/sec	Pressure(P) psi.
	0.1	10.0	0.3	1500
	1.0	6.0	3.0	900
	5.0	0.8	16.0	120

NOTE

Please note that for reciprocating applications, the compressive stress at yield should be used for design calculations. For rotary shafts use the limiting P.V. values, it is suggested that a 2:1 factor of safety is applied

NOTE

Data given are maximum values and can apply depending on specific application. Maximum ratings of temperature, pressure, or operating speeds are dependent on fluid medium, surface, gap value, and other variables such as dynamic or static service. Maximum values are not intended for use together at the same time, e.g. max temperature and max pressure. Please contact your Hallite technical representative for application support.

TYPICAL PHYSICAL PROPERTIES	METRIC	INCH
Specific Gravity	1.27	1.27
Compression Stress at Failure	450 MN/m ² @ 23°C	65000 psi @ 73°F
Compression Stress at Yield	115 MN/m ² @ 23°C	16500 psi @ 73°F
Compression Stress at Yield	58 MN/m ² @ 80°C	8500 psi @ 176°F
Coefficient of Thermal Conductivity	0.27 W/mK	0.16 Btu/hft °F
Coefficient of Thermal Expansion - Thickness	9 X 10 ⁻⁵ per °C	5 X 10 ⁻⁵ per °F
Coefficient of Thermal Expansion - Length	13 X 10 ⁻⁵ per °C	7.3 X 10 ⁻⁵ per °F
Coefficient of Dynamic Friction on Steel Surface (0.2 µmRa) / (8 µinCLA)	Dry 0.50	Dry 0.50
	Lubricated 0.06	Lubricated 0.06

BEARING STRIP TOLERANCES	L ₁ mm	S mm	L ₁ in	S in
	-0.10 -0.60	-0.02 -0.08	-0.005 -0.025	-0.001 -0.003

WIDTH OF BEARING SPLIT – W	Ød ₁ , ØD ₁ mm	W mm	Ød ₁ , ØD ₁ in	W in
	≤50	3.00 - 1.50	≤2	0.12 - 0.06
	≤120	5.00 - 3.50	≤5	0.19 - 0.14
	≤250	9.00 - 7.25	≤10	0.35 - 0.29
	≤550	17.00 - 15.00	≤ 22	0.67 - 0.59

506

BEARING

Polyester Fabric, Rod and Piston and Coil

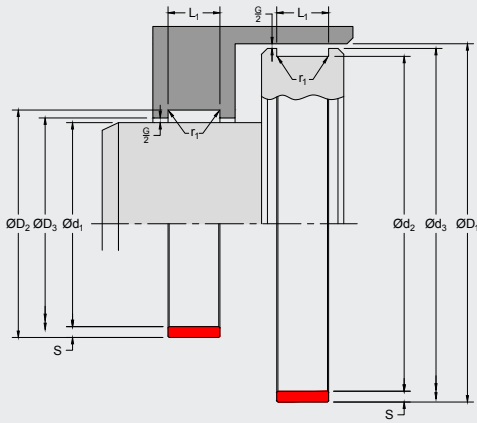

HOUSING DETAILS & TOLERANCES	METRIC		INCH	
Rod	$\text{Ø}d_1$ mm	f9	$\text{Ø}d_1$ in	f9
	$\text{Ø}D_2 = \text{Ø}d_1 + 2S$ mm	$\leq \text{Ø}80.00$ H10 $> \text{Ø}80.00$ H9	$\text{Ø}D_2 = \text{Ø}d_1 + 2S$ in	$\leq \text{Ø}3.000$ H10 $> \text{Ø}3.000$ H9
	$\text{Ø}D_3 = \text{Ø}d_1 + G$ mm	G min / max	$\text{Ø}D_3 = \text{Ø}d_1 + G$ in	G min / max
	L_1 mm	+0.20 -0	L_1 in	+0.008 -0
	Max Fillet Rad r_1 mm	0.40	Max Fillet Rad r_1 in	0.016
Piston	$\text{Ø}D_1$ mm	H11	$\text{Ø}D_1$ in	H11
	$\text{Ø}d_2 = \text{Ø}D_1 - 2S$ mm	h8	$\text{Ø}d_2 = \text{Ø}D_1 - 2S$ in	f9
	$\text{Ø}d_3 = \text{Ø}D_1 - G$ mm	G min / max	$\text{Ø}d_3 = \text{Ø}D_1 - G$ in	G min / max
	L_1 mm	+0.20 -0	L_1 in	+0.008 -0
	Max Fillet Rad r_1 mm	0.40	Max Fillet Rad r_1 in	0.016

HOUSING SURFACE ROUGHNESS	μmRa	μmRz	μmRt	μinRa	μinRz	μinRt
Dynamic Sealing Face $\text{Ø}d_1, \text{Ø}D_1$	0.4	1.6 max	4 max	16	63 max	157 max
Static Sealing Face $\text{Ø}D_2, L_1, \text{Ø}d_2$	3.2 max	10 max	16 max	125 max	394 max	630 max

NOTE

G min controls the minimum metal-to-metal clearance between the gland and rod or between bore and piston. G max controls the maximum extrusion gap seen by a seal associated with the bearing. Typically, G min should be 0.70mm/0.0280in but can be reduced when required by the extrusion gap for the seal and the build up of tolerances. The absolute minimum metal-to-metal clearance recommended is 0.10mm/0.004in. More information can be found in the Housing Designs and Extrusion Gaps pages at the front of the catalogue. For applications not using a seal, see part number range for G Max values.



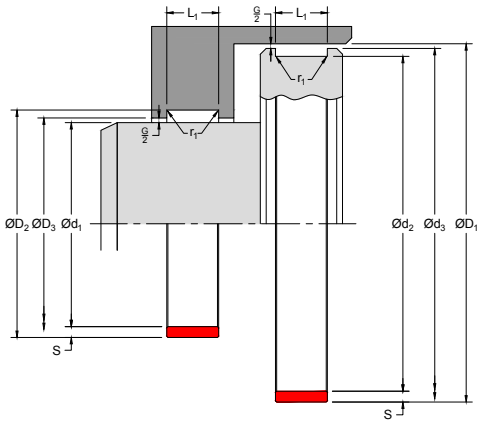

IDENTIFICATION & INSTALLATION

The ranges shown on the following pages are Hallite's most popular sizes. The section ranges identify section and groove width; from these nearly any diameter of cut ring or spiral length can be manufactured. If you cannot find the size you are looking for, please contact your local Hallite sales office for additional size information.

- Cut rings are ready made bearings cut to size to suit either rod or piston housings or ready for installation. These are ideal for medium to high volume user. A comprehensive list of cut ring sizes can be found on the Hallite web site or, in the future, the Hallite Product Finder app.
- Spiral lengths are available in a wide range of preformed diameters and are supplied in continuous lengths to suit a range of inside and outside diameters. These are ideal for lower volume users required various diameters. A range of the spiral sizes can be found in the part number listing on the following pages.
- Flat coils are packaged in a dispenser for ease of storage and handling. The flat coils are supplied in 10 metre lengths suitable for a wide range of diameters. These are ideal for using or supplying one-off bearings for small volume requirements. A range of the flat coil sizes can be found in the part number listing on the following pages.

All standard bearing strips are printed with a size reference and include distance marking every 100mm on metric size sections and every six inches on inch size sections for guidance only.

When ordering please clearly state whether cut rings, spiral lengths or flat coils are required.

For cut rings and spiral lengths please state whether the application is for a rod or piston and provide inside ($\text{Ø}d$) or outside ($\text{Ø}D$) diameters, groove width (L_1) and section (S) dimensions. Where spiral lengths are ordered also specify length required.

For flat coils please specify groove width (L_1) and section (S) dimensions.

INSTRUCTIONS FOR CUTTING BEARING STRIP TO SIZE:

1. Select the groove width (L_1) and section (S) required.
2. In the case of a rod bearing, position the bearing strip around the rod or in the case of a piston bearing, fit the bearing strip in the piston groove and mark the point of overlap. Determine the correct width of bearing split (W) for the $\text{Ø}d$ or $\text{Ø}D$ being used, as indicated in the technical details, and make a second mark.
3. Remove the strip and cut at the second marked position to the desired angle using anvil cutters or other similar cutting tool.

It is recommended that the standard cutting angle is used for the majority of applications.

If necessary, coil diameters can be resized by curing on a suitable mandrel in an oven for one hour at 120°C (250°F) and allowing to cool on the mandrel.

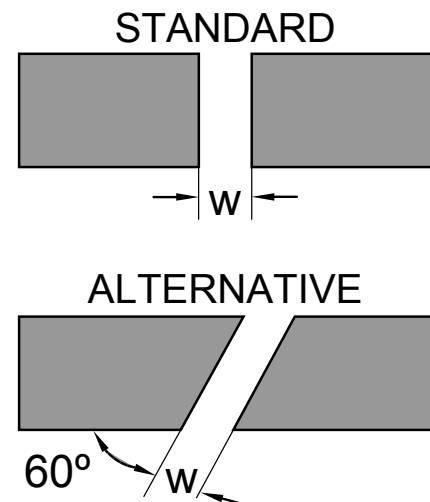

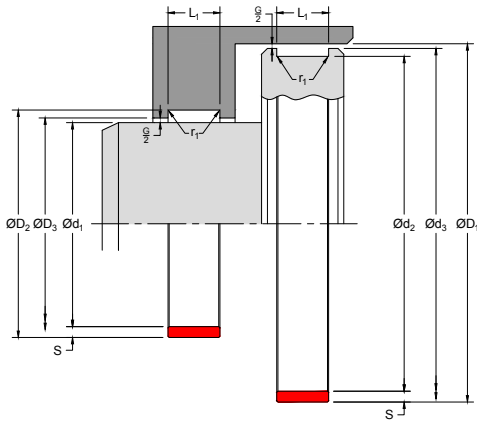

506

BEARING

Polyester Fabric, Rod and Piston and Coil

SECTION RANGE

METRIC					
S	L ₁	S	L ₁	S	L ₁
1.50	5.60	2.50	15.00‡	3.00	30.00
2.00	6.30	2.50	16.00	3.00	35.00
2.00	8.10	2.52	19.50	3.00	40.00
2.00	9.70	2.50	20.00	3.20	9.70
2.00	10.00	2.50	25.00‡	3.20	19.70
2.00	15.00	2.52	30.00	3.50	25.00
2.00	20.00	2.50	35.00	4.00	5.00
2.00	22.00	2.50	40.00	4.00	6.10
2.00	25.00	2.50	50.00	4.00	9.70
2.50	5.60‡	3.00	9.70	4.00	15.00
2.50	6.30	3.00	12.00	4.00	20.00
2.50	7.00	3.00	12.80	4.00	25.00‡
2.50	8.00	3.02	15.00	4.00	30.00
2.50	9.70‡	3.00	16.00	4.00	35.00
2.50	12.00	3.00	20.00	4.00	40.10
2.50	13.00	3.00	25.00		

NOTE Within the size range, items suffixed ‡ indicate cross sections to ISO 10766.

INCH

S	L ₁
0.063	0.375
0.125	0.375
0.125	0.500
0.125	0.625
0.125	0.750
0.125	1.000
0.125	1.500

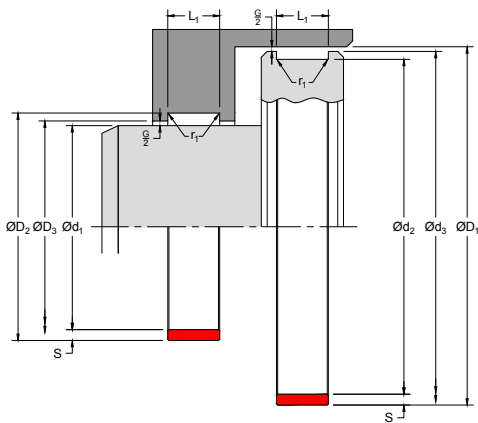

SPIRAL LENGTHS

METRIC						
$\text{Ø}d_1$	$\text{Ø}D_1$	S	L_1	G MAX	G MIN*	PART NO.
25 - 41	45 - 90	2.00	10.00		0.70	8501310
35 - 70	74 - 160	2.00	10.00		0.70	8502610
70 - 155	159 - 310	2.00	10.00		0.70	8502252
35 - 50	54 - 110	2.00	15.00		0.70	8503357
50 - 100	104 - 210	2.00	15.00		0.70	8503175
90 - 180	184 - 370	2.00	15.00		0.70	8503358
25 - 30	35 - 70	2.50	5.60		0.70	8502000‡
25 - 50	55 - 110	2.50	5.60		0.70	8502020‡
50 - 100	105 - 210	2.50	5.60		0.70	8502040‡
25 - 40	45 - 90	2.50	9.70		0.70	8502100‡
35 - 70	75 - 150	2.50	9.70		0.70	8502120‡
70 - 150	155 - 310	2.50	9.70		0.70	8502140‡
40 - 50	55 - 110	2.50	13.00		0.70	8502200
50 - 100	105 - 210	2.50	13.00		0.70	8502220
90 - 180	185 - 370	2.50	13.00		0.80	8502230
40 - 50	55 - 110	2.50	15.00	As required by the seal extrusion gap	0.70	8502300‡
50 - 100	105 - 210	2.50	15.00		0.70	8502330‡
90 - 180	185 - 370	2.50	15.00	For applications not using a seal G MAX can be 1.6mm	0.80	8502350‡
50 - 80	85 - 170	2.50	20.00		0.70	8502400
75 - 150	155 - 310	2.50	20.00		0.80	8502410
125 - 250	255 - 510	2.50	20.00		0.80	8502430
60 - 80	85 - 170	2.50	25.00		0.70	8502500‡
70 - 150	155 - 310	2.50	25.00		0.80	8502520‡
125 - 250	255 - 510	2.50	25.00		0.80	8502530‡
40 - 50	56 - 100	3.00	9.70		0.80	8503369
50 - 100	106 - 210	3.00	9.70		0.80	8503370
100 - 150	156 - 310	3.00	9.70		0.80	8503371
50 - 60	66 - 120	3.00	12.80		0.70	8503037
60 - 104	110 - 220	3.00	12.80		0.80	8503038
90 - 149	155 - 300	3.00	12.80		0.80	8503039
55 - 80	86 - 170	3.00	20.00		0.80	8503124
80 - 150	156 - 310	3.00	20.00		0.80	8502635
140 - 250	256 - 510	3.00	20.00		0.80	8503189
50 - 75	81 - 160	3.02	15.00		0.70	8502734
60 - 80	68 - 170	4.00	6.10		0.80	8503359

NOTE

*G MIN value can be reduced if required by the seal's maximum extrusion gap. Refer to Housing Design section in the front of catalogue. ‡ Within the size range, items suffixed ‡ indicate cross sections to ISO 10766.



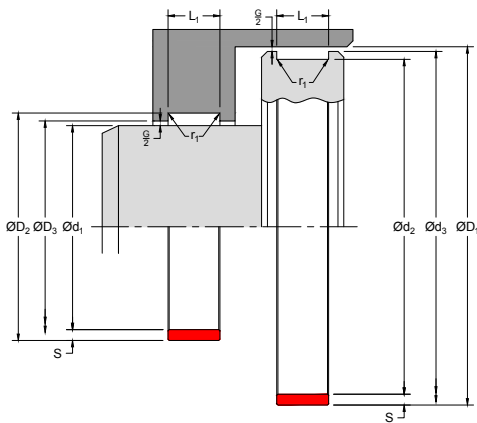

506

BEARING

Polyester Fabric, Rod and Piston and Coil

SPIRAL LENGTHS - CONTINUED

METRIC						
Ød ₁	ØD ₁	S	L ₁	G MAX	G MIN*	PART NO.
80 - 150	158 - 310	4.00	6.10		0.80	8503360
150 - 250	258 - 510	4.00	6.10		0.80	8503361
60 - 80	88 - 170	4.00	9.70		0.80	8503362
80 - 150	158 - 310	4.00	9.70		0.80	8503363
150 - 250	258 - 510	4.00	9.70		0.80	8503364
60 - 80	88 - 170	4.00	20.00	As required by the seal extrusion gap	0.80	8503365
80 - 150	158 - 310	4.00	20.00		0.80	8503366
150 - 250	258 - 510	4.00	20.00	For applications not using a seal G MAX can be 1.6mm	0.80	8503191
120 - 150	158 - 310	4.00	25.00		0.80	8503367‡
150 - 250	258 - 510	4.00	25.00		0.80	8503192‡
120 - 150	158 - 310	4.00	30.00		0.80	8503368
150 - 250	258 - 510	4.00	30.00		0.80	8503193
170 - 200	208 - 410	4.00	40.10		0.80	8503179
200 - 300	308 - 610	4.00	40.10		0.80	8503180

NOTE

*G MIN value can be reduced if required by the seal's maximum extrusion gap. Refer to Housing Design section in the front of catalogue. ‡ Within the size range, items suffixed ‡ indicate cross sections to ISO 10766.

INCH						
Ød ₁	ØD ₁	S	L ₁	G MAX	G MIN*	PART NO.
1.000 - 1.375	1.625 - 3.500	0.125	0.375		0.031	8502098
1.250 - 1.875	2.125 - 4.250	0.125	0.375		0.031	8502099
2.000 - 3.500	3.750 - 6.250	0.125	0.375		0.031	8502183
1.250 - 1.750	2.000 - 4.000	0.125	0.500		0.031	8502089
1.750 - 3.500	3.750 - 6.250	0.125	0.500	As required by the seal extrusion gap	0.031	8502090
3.500 - 6.000	6.250 - 10.000	0.125	0.500		0.031	8502091
8.000 - 12.500	12.750 - 25.000	0.125	0.500		0.031	8502720
2.000 - 3.500	3.750 - 6.250	0.125	0.625	For applications not using a seal, G MAX can be 0.080in	0.031	8502092
3.500 - 6.000	6.250 - 10.000	0.125	0.625		0.031	8502093
2.000 - 3.500	3.750 - 6.250	0.125	0.750		0.031	8502094
3.500 - 6.000	6.250 - 10.000	0.125	0.750		0.031	8502095
2.500 - 3.500	3.750 - 6.250	0.125	1.000		0.031	8502096
3.500 - 6.000	6.250 - 10.000	0.125	1.000		0.031	8502097
8.000 - 12.500	12.750 - 25.000	0.125	1.000		0.031	8502222

NOTE

*G MIN value can be reduced if required by the seal's maximum extrusion gap. Refer to Housing Design section in front of catalogue.



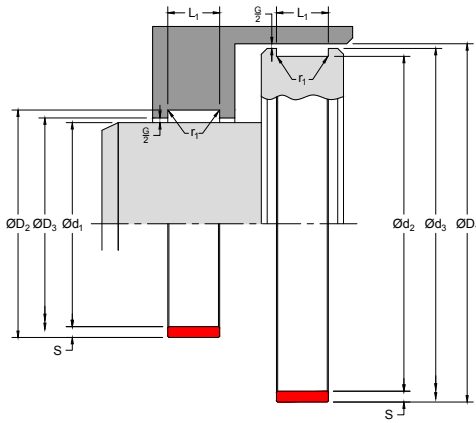

FLAT COILS

METRIC						
Ød ₁	ØD ₁	S	L ₁	G MAX	G MIN*	PART NO.
140.00	190.00	1.50	5.60		0.70	8581810
140.00	210.00	2.00	9.70		0.70	8581910
140.00	210.00	2.00	10.00		0.70	8584610
140.00	210.00	2.00	20.00		0.70	8582210
140.00	210.00	2.00	15.00		0.70	8581210
140.00	230.00	2.50	5.60		0.70	8580010‡
140.00	230.00	2.50	6.30	As required by the seal extrusion gap	0.70	8581310
140.00	230.00	2.50	8.00		0.70	8581610
140.00	230.00	2.50	9.70		0.70	8580110‡
140.00	230.00	2.50	13.00	For applications not using a seal G MAX can be 1.6mm	0.70	8581110
140.00	230.00	2.50	15.00		0.70	8580210‡
140.00	230.00	2.50	20.00		0.80	8580310
140.00	230.00	2.50	25.00		0.80	8580410‡
140.00	230.00	2.50	30.00		0.70	8582010
140.00	240.00	3.00	9.70		0.70	8581410
140.00	240.00	3.00	12.80		0.70	8581010
140.00	240.00	3.00	20.00		0.70	8581510
140.00	240.00	3.02	15.00		0.70	8581710

NOTE * G MIN value can be reduced if required by the seal's maximum extrusion gap. Refer to Housing Design section in the front of catalogue. ‡ Within the size range, items suffixed ‡ indicate cross sections to ISO 10766.

INCH						
Ød ₁	ØD ₁	S	L ₁	G MAX	G MIN*	PART NO.
5.500	9.750	0.125	0.375	As required by the seal extrusion gap	0.031	8580510
5.500	9.750	0.125	0.500		0.031	8580610
5.500	9.750	0.125	0.625	For applications not using a seal, G MAX can be 0.080in	0.031	8580710
5.500	9.750	0.125	0.750		0.031	8580810
5.500	9.750	0.125	1.000		0.031	8580910

NOTE *G MIN value can be reduced if required by the seal's maximum extrusion gap. Refer to Housing Design section in front of catalogue.

NOTE For a comprehensive list of all Hallite 506 cut ring sizes and part numbers for rod and piston applications, please refer to the Hallite website.